

ULTRASONIC TESTER

UK1401 SURFER

OPERATION MANUAL



Acoustic Control Systems – Solutions GmbH
Saarbrücken 2020



CONTENTS

1 DESCRIPTION AND OPERATION OF THE INSTRUMENT.....	6
1.1 THE INTENDED USE OF THE INSTRUMENT.....	6
1.1.1 Intended Use and Application Range.....	6
1.1.2 Operating Conditions.....	7
1.2 TECHNICAL SPECIFICATIONS.....	7
1.3 INSTRUMENT DESIGN AND OPERATION PRINCIPLE.....	8
1.3.1 Design.....	8
1.3.2 Operation Principle.....	10
1.3.3 Operation Modes.....	10
1.3.4 Screen of the Instrument.....	11
1.3.5 Keyboard.....	14
2 PROPER USE OF THE INSTRUMENT.....	16
2.1 OPERATING RESTRICTIONS.....	16
2.2 MAKING INSTRUMENT READY FOR OPERATION.....	16
2.2.1 Preparation of the Surface.....	16
2.2.2 Switch On/Off the Instrument.....	16
2.2.3 Functional Check.....	16
2.3 WORKING WITH THE INSTRUMENT.....	18
2.3.1 SETUP mode.....	18

2.3.2 TIME / VELOCITY Modes	27
2.3.3 CRACK mode.....	30
2.3.4 FRONT mode	32
2.4 TRANSFER DATA TO PC.....	41
3 MAINTENANCE.....	42
3.1 ACCUMULATOR.....	42
3.2 CHARGING THE ACCUMULATOR.....	42
3.3 TROUBLESHOOTING	42
4 STORAGE	43
5 TRANSPORTATION	44

The present operation manual (hereinafter referred to as “the manual”) includes information on the technical specifications, description of the design and operation principle, as well as well as information on proper use of the UK1401 Surfer Ultrasonic Testers (hereinafter referred to as “the testers” or the “instruments”).

Carefully study this Operation Manual prior to working with the instrument.

The “ACS” company continuously upgrades the quality and functions, improves the safety and serviceability of its instruments, hence during the production of the instruments some minor modifications can be introduced to them that don't affect the technical specifications, and thus they may be omitted in current version of the operation manual.

The instrument is manufactured by:

ACS-Solutions GmbH
Science Park 2
66123 Saarbrücken, Germany

Phone: +49 (0) 681-96592270
Fax: +49 (0) 681-96592280
E-mail: info@acs-international.com
Website: www.acs-international.com

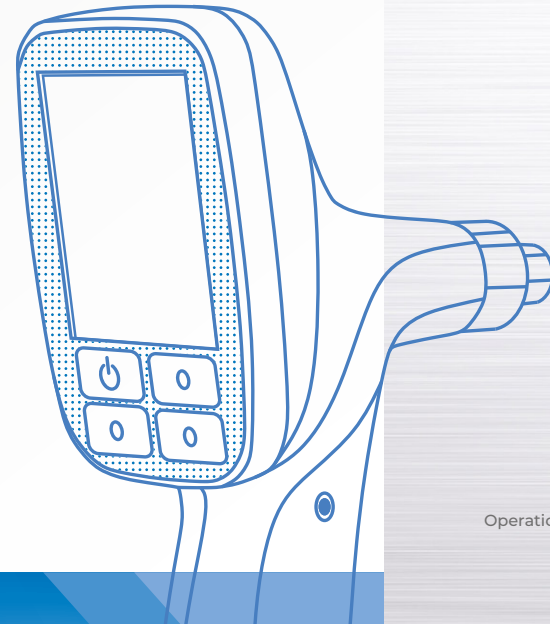



1

DESCRIPTION AND OPERATION OF THE INSTRUMENT

1.1 THE INTENDED USE OF THE INSTRUMENT

1.1.1 Intended Use and Application Range

UK1401 SURFER Ultrasonic Testers are designed for measurements of time and propagation velocity of longitudinal ultrasonic waves in solid materials when doing surface scanning on a rigid foundation in order to determine the strength and soundness of materials and facilities.

The main application areas of the instruments:

- the evaluation of the concrete strength by means of the ultrasonic sound velocity using indirect measurement method (surface pulse velocity testing) according to following international standards:

- GOST 17624 2012;
- DIN EN 12504 4;
- BS 1881 : Part 203 : 1986;
- ASTM C597 16;
- IS 13311 1.

- the evaluation of the concrete strength of the serviced structures along with the "separation with chopping off" procedure;

- evaluation of the load carrying capacity of concrete supports and pillars made of centrifugally cast concrete based on the relation of the ultrasonic sound propagation velocities in the directions along and across of the support axis.

Additional features:

- searching for near-surface defects in concrete structures by abnormal velocity decrease or increase of ultrasound propagation time in the defective (unsound) spot/areas as compared to the areas without defects;
- evaluation of the depth of the cracks facing the concrete or stone surface;
- evaluation of the porosity and cracked structure of subsurface rock, anisotropy degree and structure of composite materials;
- evaluation of the similarity or difference of elastic properties of the materials or samples of the same material as compared to each other, as well as material age provided their properties change over a period of time.

Technical solutions used to produce the instruments, are protected by the Russian Federation Patent No. 2082163.

1.1.2 Operating Conditions

The instruments are designed for operation under the following conditions:

- ambient air temperature: from -30 to +55 °C;
- relative air humidity up to 95 % at + 35 °C.

1.2 TECHNICAL SPECIFICATIONS

The main technical specifications of the device are listed in the Table 1

Table 1

Parameter name	Value
Operational frequency, kHz	50
Measurement base, mm	150±1
Indication discreteness of propagation time of ultrasonic waves, µs	0.1
Indication discreteness propagation velocity of ultrasonic waves, m/s	10
Measurement range of propagation time of longitudinal ultrasonic waves, µs	from 10 to 200
Measurement range of propagation velocity of longitudinal ultrasonic waves, m/s	from 1 000 to 10 000
Limits of permissible absolute measurement error of propagation time of ultrasonic waves, µs, where t – measured time value	±(0.01·t+0.1)
Limits of permissible absolute measurement error of propagation velocity of ultrasonic waves, m/s, where c – measured velocity value	±(0.01·c+10),
Nominal voltage, V	3.3
Period of continuous operation of the instrument with 80% value of screen brightness, at 25 °C, working with 6 Hz measurement frequency, min.	16 hours

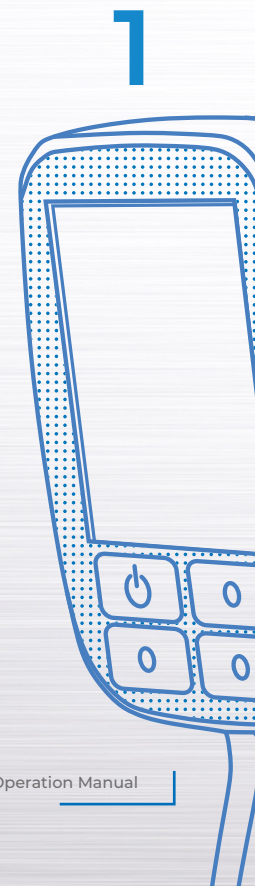

Table 1

Parameter name	Value
Overall dimensions of the instrument, mm, max.	235x145x70
Maximum weight of the instrument, max.	490 g
Average time between failures	18,000 hours
Average service life	5

1.3 INSTRUMENT DESIGN AND OPERATION PRINCIPLE

1.3.1 Design

The instrument represents an electronic unit (Figure 1) enclosed into a plastic case in which two spring-driven ultrasonic transducers (transmitting and receiving) are rigidly mounted. Ultrasonic transducers have cone-type protectors. The ceramic wear proof nozzles are fixed on tops of the protectors.

Due to almost spot acoustic contact of the transducers with surface of the inspected material, there is no need for coupling fluid to establish acoustic coupling with the inspected object.

The upper part of the face panel of the electronic unit bears a color TFT screen. The screen displays measurement results and service information required to control the instrument. The instrument's screen ensures full visual monitoring of the inspection process with the help of color indication.



Figure 1

A membrane keyboard enabling control over the instrument is located under the screen.

The opposite side of the case bears the ENTER button (Figure 2).

The lower end face panel of the electronic unit bears the fastener for the belt and an USB Micro B connector used for connection to a PC via the USB cable and charging of the built-in accumulator by means of the AC adapter 220 V – USB (Figure 3).

Figure 2



Figure 3

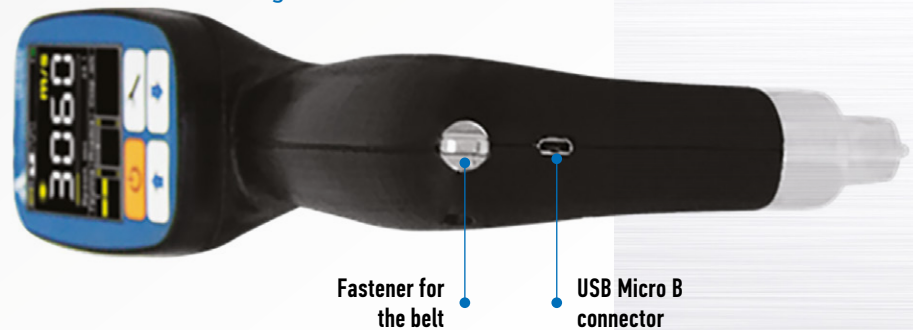

1

1



1.3.2 Operation principle

The instrument measures the time interval during which the ultrasonic pulse goes through the inspected object from the transmitting transducer to the receiving transducer. The ultrasonic sound velocity is determined by dividing the distance value between the points of emission and receiving points of ultrasonic waves, by the measured time value. The ultrasonic pulse emission and reception are periodically repeated to increase the measurement reliability. The final value obtained after processing of the sequence of several received ultrasonic signals is displayed on the screen.

Ultrasonic pulses go through the inspected object close to its surface in the form of elastic waves of various types. The instrument counts the measured time interval according to the earliest impulse coming to the receiving transducer. Therefore, the instrument measures velocity of the acoustic waves propagating through the given material with the highest velocity.

Primary energy of ultrasonic pulses propagates in the near-surface 2-3 cm thick layer of the material. If there is some kind of imperfection of material (cavity or crack close to surface) in the way of the wave, then the wave will bypass it and will arrive to the receiver in the weakened state or with delay as compared to the place without structural imperfection. In that case, the lower velocity of sound or longer propagation time of the ultrasonic wave as compared to other spots (areas) are a sign of a defect in the material structure invisible from the surface.

If the crack faces the surface, then it will completely block the path of the ultrasonic wave along the surface. In that case, only a small part of the wave energy can bypass the crack within the material (up to 50 mm in the depth) and return to the receiving transducer. Due to longer path, its propagation time will exceed the propagation time of the wave going the shortest path (without a crack) between the transducers. The measurement process of the crack depth is based on comparison of these time intervals.

1.3.3 Operation modes

The instrument can be operated in the following modes:

- VELOCITY – measurement of propagation velocity of ultrasonic waves in the material;
- TIME – measurement of propagation time of ultrasonic waves in the material;
- FRONT – measurement of the time interval from the moment the when the signal exceeds the threshold level for the first

time (the threshold value is set automatically according to the noise peaks) to the moment when the first half wave of the signal will reach its maximum;

- CRACK – evaluation of the depth of the crack facing the surface;
- STRENGTH – the evaluation of the concrete strength in solid and combined concrete and reinforced concrete structures, installations and facilities using the ultrasonic technique and according to the recommendations of the standard GOST17624 2012 “Types of concretes. Ultrasonic testing and strength evaluation”;
- SETUP – adjustment and selection of the measurement parameters.

1.3.4 Screen of the instrument

The upper line displayed on the screen indicates the information on the current operation mode and battery charge level in all operation modes. The icons of the operation modes are given in the Table 2. The icons of the measurement modes are always arranged from left to right as follows: VELOCITY – TIME – FRONT LINE – CRACK – STRENGTH. The active mode is highlighted in yellow (Figure 4).

The icons informing on the presence and strength of the signal, measurement units and numeric value of the measurement result are constantly displayed in all modes.

Table 2

Tab	Operation mode
V	VELOCITY
t	TIME
Δt	FRONT
h	CRACK
R	STRENGTH



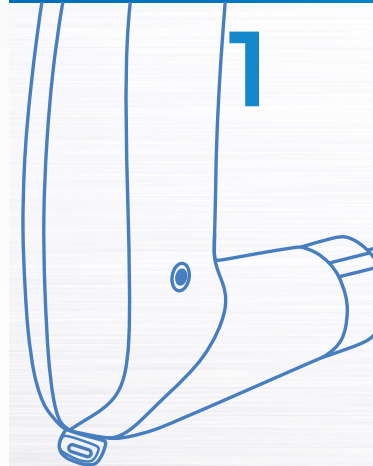

Figure 4



The icons informing on the presence and strength of the signal, measurement units and numeric value of the measurement result are constantly displayed in all modes.

Table 3 contains description of the acoustic contact indicators.

Table 3

Type of the indicator	Description
	Very high signal level. The AGC should be switched off
	Maximum signal level. The amplification of the receive path is set to minimum value
	Average signal level. The amplification of the receive path is set to the average value
	Minimum signal level. The amplification of the receive path is set to the maximum value
	There is no signal or the signal is too weak for measurements

Display of the instrument in the VELOCITY mode is shown in the Figure 5.
 Display of the instrument in the TIME mode is shown in the Figure 6.



Figure 5

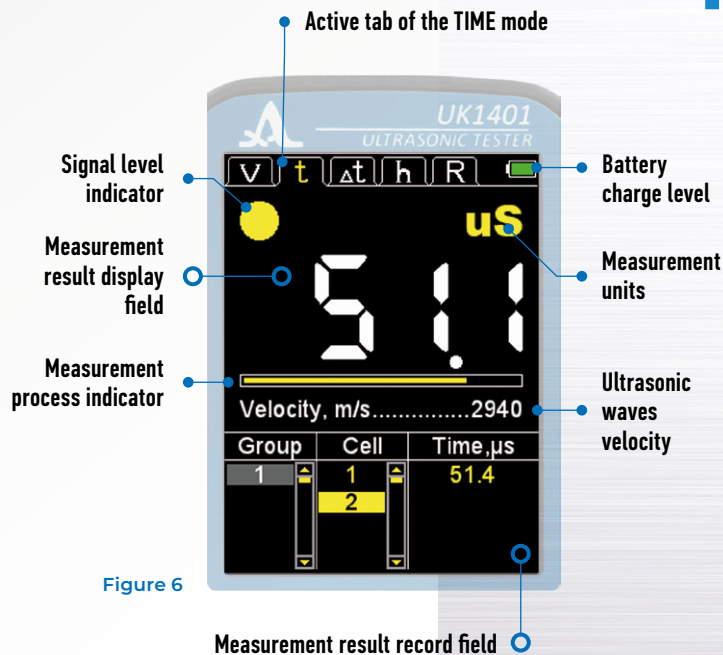

Figure 6

Display of the instrument in the FRONT mode is shown in the Figure 7.
 Display of the instrument in the CRACK mode is shown in the Figure 8.
 On the Figure 9 the display of the device in the STRENGTH mode during measurements is shown.

1

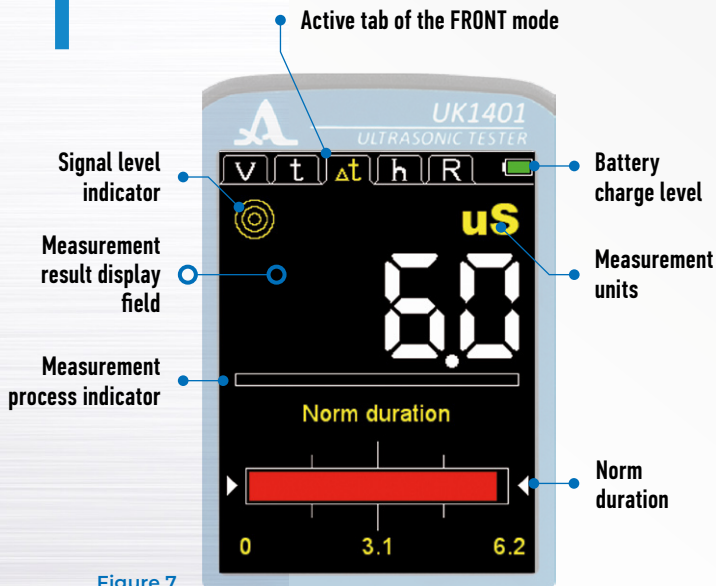

Figure 7

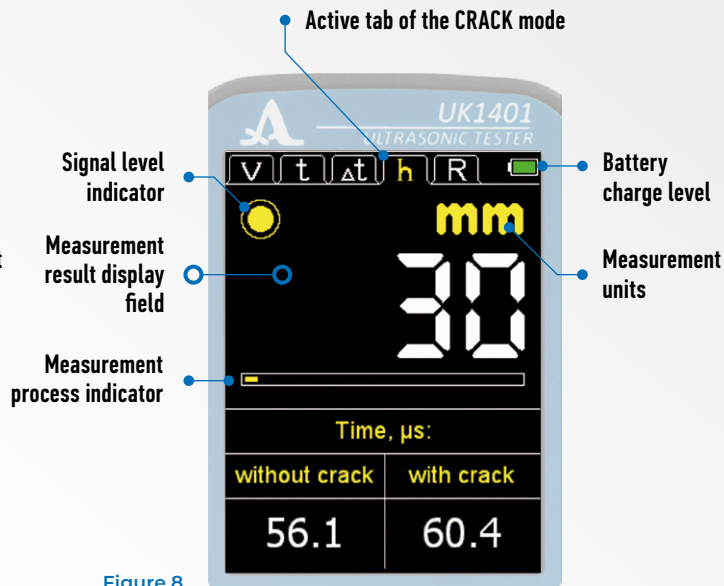



Figure 8

1.3.5 Keyboard



There are three functional keys and the On/Off key on the keyboard (Figure 10).

Main key functions:

- The key  (ON / OFF) is used to switch On/Off the instrument.

ATTENTION: THE INSTRUMENT WILL AUTOMATICALLY SWITCH OFF AFTER 10 MINUTES IN THE STANDBY MODE (NO KEY IS PRESSED, NO MEASUREMENT IS PERFORMED). AFTER 2 MINUTES THE DISPLAY BRIGHTNESS WILL AUTOMATICALLY BE SET TO THE MINIMAL LEVEL, IF NO KEY IS PRESSED DURING THIS TIME OR NO MEASUREMENT IS PERFORMED!

- The  key is used to switch from the measurement modes to the SETUP mode and vice versa.

- The   keys are used to select and configure the active parameters. Their functions are common for different operation modes. The keys are user-friendly since their icons indicate their functions.

Active tab of the STRENGTH mode

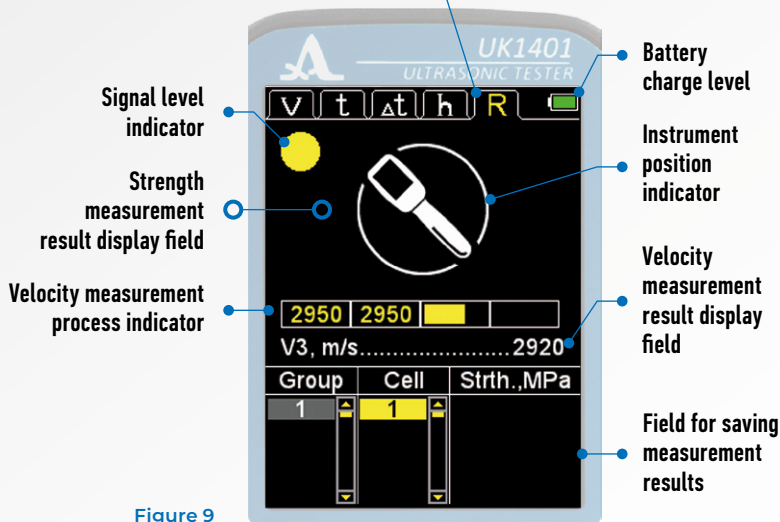

Figure 9

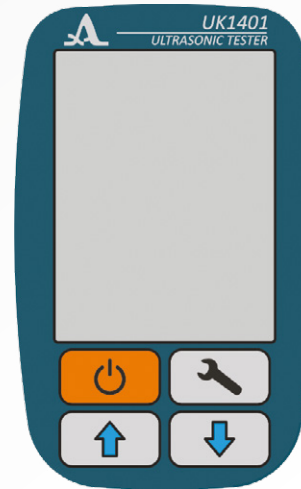
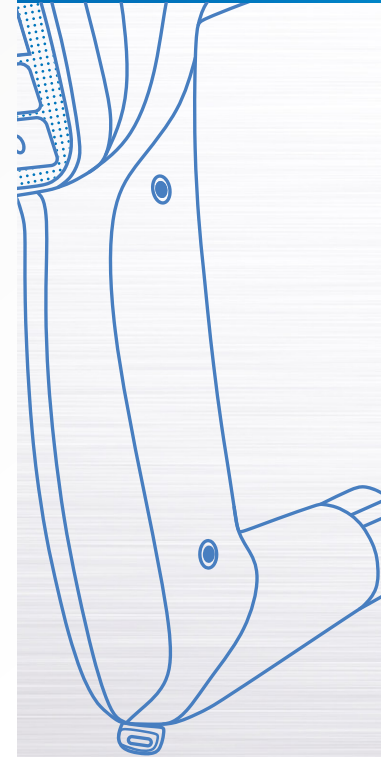

Figure 10





2

PROPER USE OF THE INSTRUMENT

2.1 OPERATING RESTRICTIONS

The instrument is designed to be operated under conditions listed in Section 1.1.2.

2.2 MAKING INSTRUMENT READY FOR OPERATION

2.2.1 Preparation of the Surface

The surface of the inspected object must be cleaned of dirt and sand.

2.2.2 Switch On/Off the Instrument

Press the  key to switch On the instrument.

A start-up window is displayed on the screen, including the name and the firm-ware version of the instrument (Figure 11).

The instrument will automatically enter the last active mode, all the corresponding settings are saved.

Press the  key to switch off the instrument or wait 10 minutes without pressing any key or performing measurements for the instrument to switch Off automatically.

All the adjustments are saved when the thickness gauge is switched off or its battery is dead.

2.2.3 Functional Check

Use a reference Plexiglas sample included in the delivery kit for instrument functional check. The sample bears a time value that a properly operating instrument should indicate at 20°C.

Functional check procedure:



Figure 11

2

- Switch On the instrument.
- Select TIME as an observed value.
- Place the instrument on the reference sample as indicated in the Figure 12.
- Apply pressure on the instrument and fix it.
- Wait for 15 20 seconds for the readings to become stable.
- Read and record at least 5 measurement readings.
- Remove the instrument from the sample.
- Calculate average time value according to the received data.
- Measure actual temperature of the reference sample.
- Find the difference between the 20°C and actual temperatures.
- If actual temperature is different from 20°C, then subtract the temperature difference value, multiplied by 0.07 μs , from the calculated average time value.
- Compare the result with the time values specified on the sample.

NOTE: THE INSTRUMENT READINGS MUST NOT DIFFER FROM THE TIME VALUE SPECIFIED ON THE REFERENCE SAMPLE BY MORE THAN 2 μs EITHER WAY! IF THEY DIFFER BY MORE THAN 2 μs , CONTACT THE MANUFACTURER.





Figure 12

2

2.3 WORKING WITH THE INSTRUMENT

2.3.1 SETUP mode

The SETUP mode includes the following options: list of the configurable parameters and calibration procedures. All the adjustments will be saved when the instrument is switched Off, or its battery is dead.

The screen of the instrument in the SETUP mode is shown in the Figure 13. The  /  keys allow:

- navigation of the active line along the menu options, the navigation is performed cyclically in both directions. The parameter highlighted in the active line becomes selectable or editable;
 - edit the parameter value;
- ENTER button allows:
- select the parameter to be configured.
 - save the new parameter value.

The menu options of the SETUP mode, their parameters (in the metric system of units) and functions are listed in the Table 4



Figure 13

Table 4

Menu option (parameter)	Parameter value	Description
Mode	velocity / time / frontline / crack / strength	Selects the measurement mode
Norm, μ s (in the FRONT mode only)	from 0.1 to 20.0	Sets the normative value of duration of the rising edge (front) of the signal
Class (in the STRENGTH mode only)	B7.5...B35 / B35...B60	Selecting the concrete type
Accumulation, Qty	4 / 8 / 16 / 32 / 64	Sets quantity of accumulations
Frequency, Hz	from 2 to 25	Repetition frequency of the sounding pulses
Clear memory, %	Occupied memory volume in %	Starts the memory cleaning procedure
Sound	On / Off	Monitoring the sound indication
Vibration	On / Off	Monitoring the vibration indication
Language	Russian / English	Selects the interface language
Measuring units	mm / inches	Selects the measurement unit system
Brightness, %	from 10 to 100	Sets the display brightness
Current time	Editable	Sets date and time

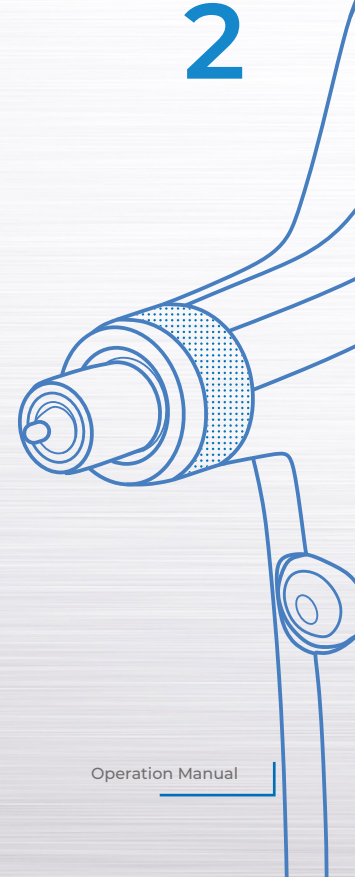

2

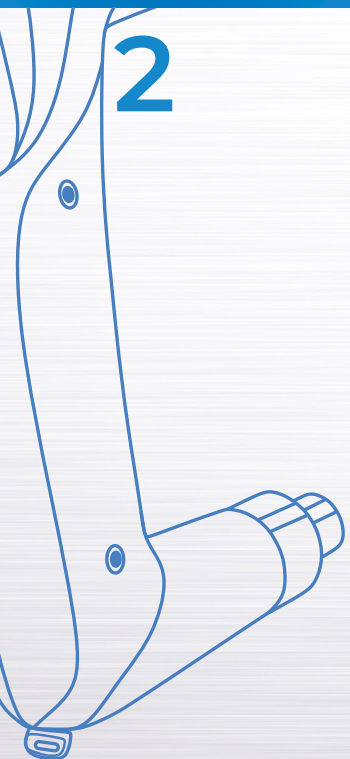

2.3.1.1 MODE OPTION

Select the measurement mode:

- VELOCITY- measurement of propagation velocity of ultrasonic waves in the material;
 - TIME - measurement of propagation time of ultrasonic waves in the material;
 - FRONT - measurement of the time interval from the moment when the signal exceeds the threshold value for the first time (threshold value is set automatically by the noise peaks) to the time when the first half-wave of the signal reaches the maximum value.
 - CRACK - evaluation of the depth of the crack facing the surface;
 - STRENGTH - the evaluation of the concrete strength.
- ENTER button sequential switching between the modes.
The MODE option screen is shown in the Figure 14.

2.3.1.2 NORM Option (in the FRONT mode only)

Setting of the rated value duration of the rising edge (front) of the signal.
The permissible value range is from 0.1 to 20.0 μ s.
The screen for the NORM option is shown in the Figure 15.

2.3.1.3 The item CLASS (in the STRENGTH mode only)

Selecting the class range of the concrete strength.
The permissible values are B7.5..B35 / B35..B60.
The button „ENTER“ is used to switch between the ranges.
According to the selected range the following general-purpose gauging dependences are used in terms of ultrasonic velocity (V) and concrete strength (R) in concrete structures of the project classes:



Figure 14

2

- B7,5 - B35: $R=0,016 \cdot V - 27,3$;
- B35 - B60: $R=0,02 \cdot V - 37,6$.

The specified dependences are used to perform a rough evaluation of the concrete strength between 12,5 and 45 MPa and between 45 and 75MPa accordingly during the surface scanning with the 150 mm base line.

On the Figure Figure 16 you see the display with the item CLASS.

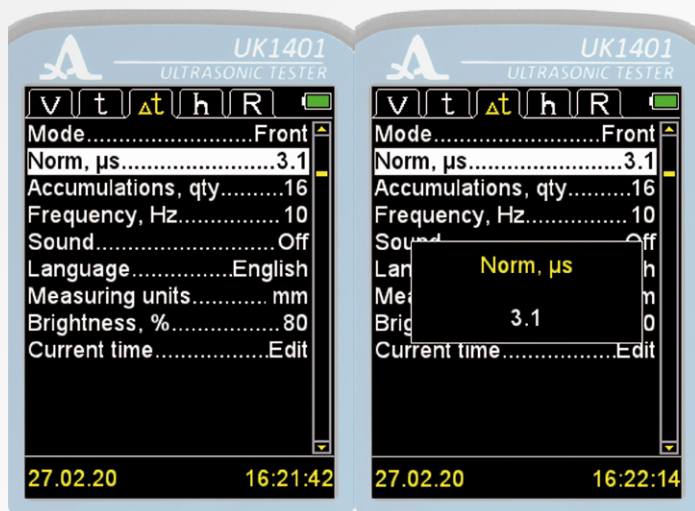

Figure 15

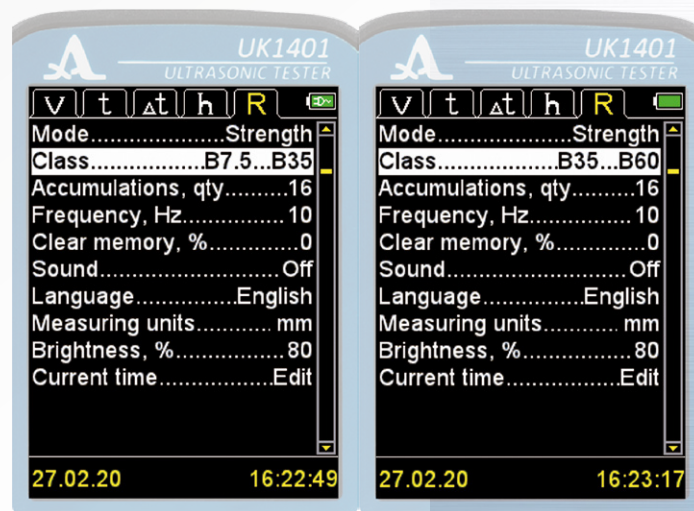

Figure 16

2.3.1.4 ACCUMULATION Option

Setting the quantity of accumulations.

The permissible value range is 1, 2, 4, 8, 16, 32, 64.

The screen for the ACCUMULATION option is shown in the Figure 17.

2.3.1.5 FREQUENCY Option

Setting the repetition frequency of the sounding pulses.

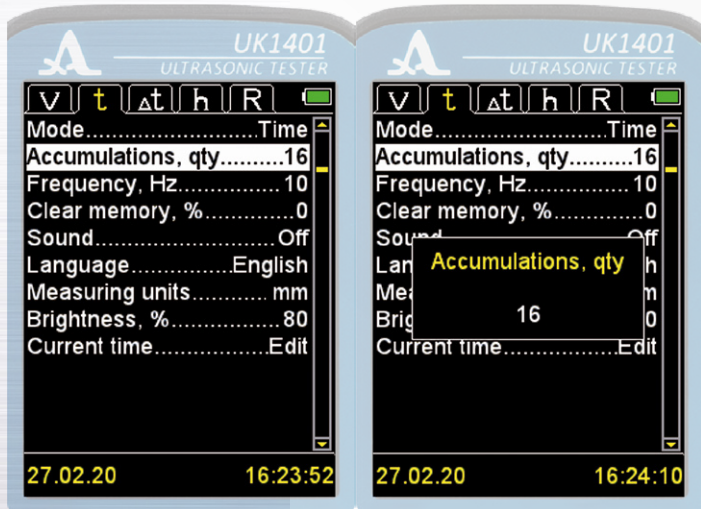

Figure 17

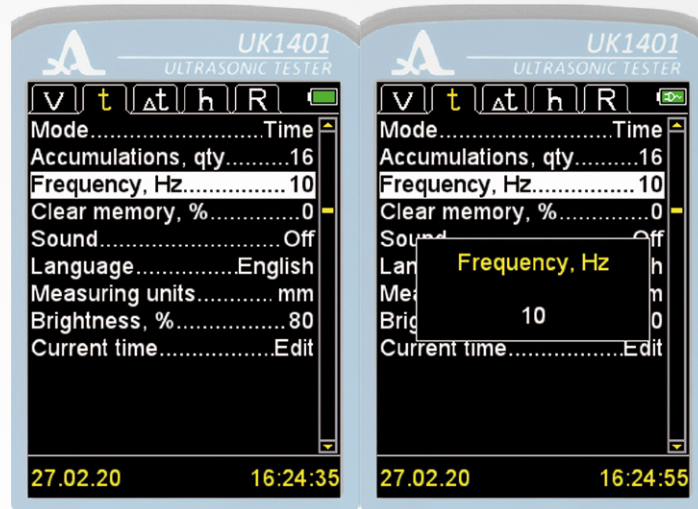

Figure 18

The permissible value range is from 2 to 25 Hz.

The screen for the FREQUENCY option is shown in the Figure 18.

To increase the testing quality, try to select the highest possible value of the repetition frequency of the sounding pulses. However, when inspecting the small items (not exceeding several dozen centimeters) with low attenuation, the ultrasonic vibrations in the material will not have time to fade completely by the time when the next sounding signal will be sent to the material, thus it can result in false readings. In that case, the repetition frequency of the sounding pulses should be decreased, if required, to the minimum value.

2.3.1.6 CLEAR MEMORY Option

Deletion of the measurement results from the memory.

The parameter indicates the filling percentage of the memory with the measurement results.

There are two separate memory units for the modes:

- VELOCITY, TIME;
- STRENGTH.

The screen for the CLEAR MEMORY option is shown in the Figure 19.

After the memory cleaning is started, the “Saved data will be deleted. Continue?” message will be displayed (Figure 20).



Figure 19

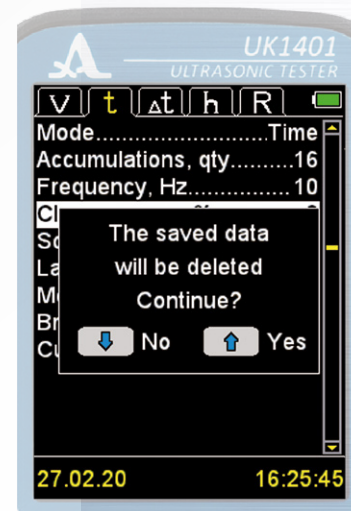

Figure 20

2.3.1.7 SOUND Option

Switching ON/OFF the sound of the instrument.

To improve the usability of the instrument, the main events occurring during measurements, adjustments, and when the keys are pressed, are accompanied by sounds.

As well, the sound indication is used for acoustic monitoring of the ultrasonic signals reception. The acoustic signals inform the operator about the processes, and do not affect the measurement results at that.

The screen for the SOUND option is shown in the Figure 21.



Figure 21

2.3.1.8 LANGUAGE Option

Select the interface language of the instrument:

- Russian;
- English;

The screen for the LANGUAGE option is shown in the Figure 22.

2.3.1.9 MEASURING UNITS Option

Selecting the measurement units of the system: mm / inches.

2.3.1.10 The screen for the MEASURING UNITS

The option is shown in the Figure 23.

2.3.1.11 BRIGHTNESS Option

The value setting range of display brightness is from 10 to 100 %.

The screen for the BRIGHTNESS option is shown in the Figure 24.

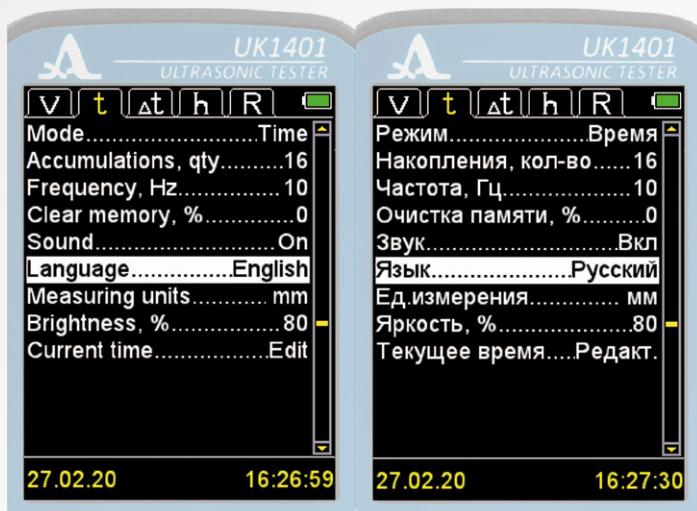

Figure 22

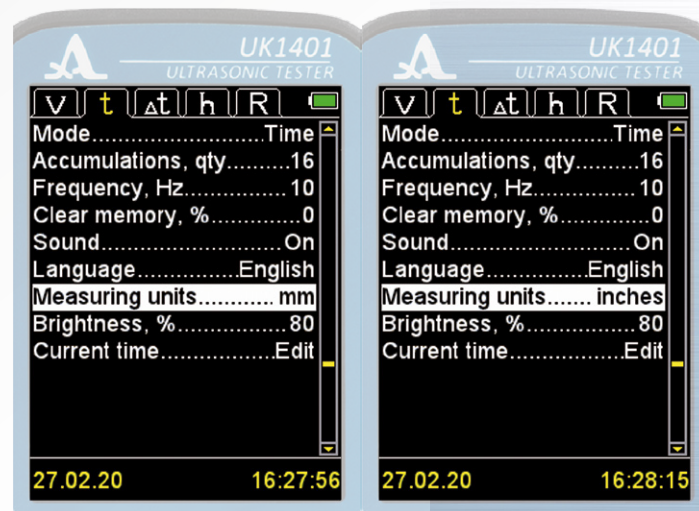

Figure 23

2.3.1.12 CURRENT TIME Option

Setting date and time.

The screen for the CURRENT TIME option is shown in the Figure 25.

The button „ENTER“ is used to select the parameters for editing (highlighted red): DAY→MONTH→YEAR→HOURS→MINUTES→exit the editing;



The buttons  /  are used to change the value of the selected parameter;



Figure 24



Figure 25

2.3.2 TIME / VELOCITY Modes

In the TIME / VELOCITY modes the screen is divided into two areas: the upper one displays the information on measurement, the lower displays the information on the results already recorded in the TIME / VELOCITY modes (groups, group cells and measurement results in μs or m/s depending on the selected operation mode) (Figure 26).

Place the instrument on the inspected object with both ultrasonic transducers, trying to position it so that the transducers are perpendicular to the surface of the object. Immediately after the transducers touch the surface of the object being inspected, the instrument switches from the standby mode (seldom sending of the sounding pulses) into the active state (often sending of the sounding pulses).



If the sound indication is On, the measurements are accompanied by short sound signals. If sound signals are missing, it indicates that the instrument is not in the active state. I.e. either the ultrasonic velocity in the material of the inspected object is below the minimum permissible value, or there is a crack in the area between the transducers that prevent the ultrasonic signal from passing to the receiving transducer.



After the measurements are completed and the instrument is removed from the inspected object, the measurement result will remain on the screen for 10 to 15 seconds, after that it will change into horizontal strokes.

While measuring try to hold the instrument motionless if possible.

If the measurement results in the same place of inspection substantially differ, decrease the repetition frequency of the sounding pulses. To do that, select the FREQUENCY option in the SETUP mode and decrease its value. Repeat the measurements in the same place of the inspected object.

Active keys:

  – holding – navigating the columns of the group – CELL – RESULT in corresponding direction;

  – short pressing – navigating the lines of the active column in corresponding direction.

2

Figure 26

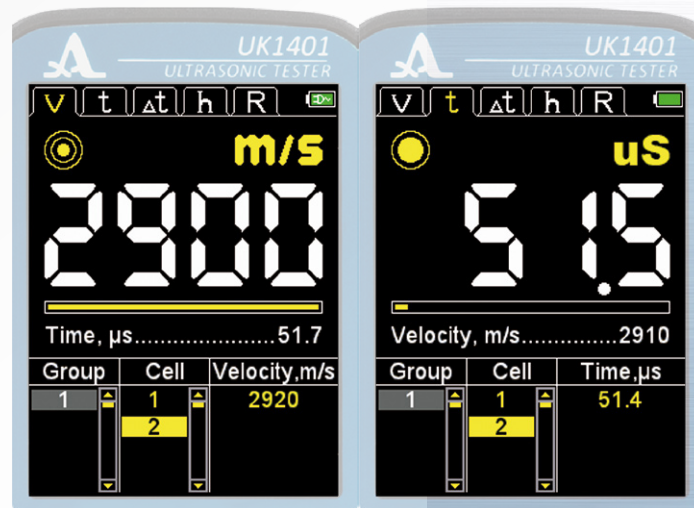

2

2.3.2.1 Add new last group

Use the  key to switch to the last group. The user will be prompted to add a new group. If the group is not empty, then the group will be added under the next serial number. If the last group is empty, then the user will be informed and no group will be added (Figure 27).

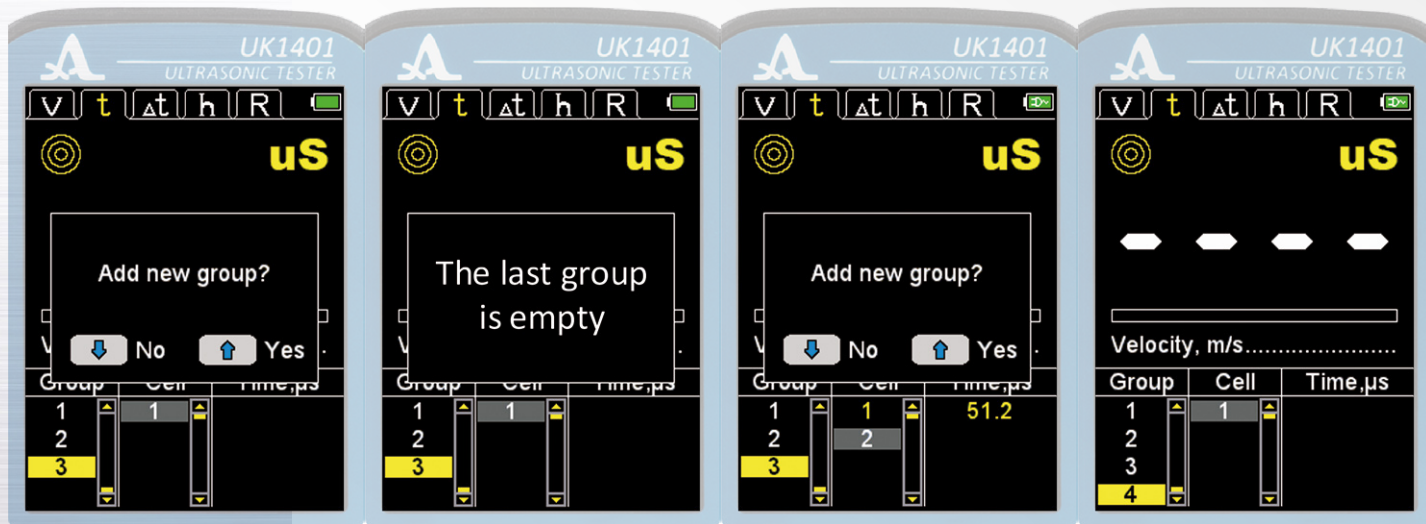

Figure 27

2.3.2.2 RECORDING the Result

The measurement results are stored in the cells of the memory. The cells form groups. The groups and the cells in the groups are identified by the serial numbers. The numbering of the groups and the cells in each group is started with "1".

The maximum quantity of the cells in a group is 500.

The maximum quantity of all groups is 100.

When the quantity of the cells in a group becomes maximum, a corresponding message is indicated on the display.

In practice, it is more convenient to record the results into small groups (by several dozen values). You can return to any existing group if required and continue recording the results in it.

To record a result, select any existing group or create a new one prior to measurements, and press the ENTER button. The measurement result will be saved in the last cell of the current group.

2.3.2.3 Viewing and a djusting the measurement results

The user can view any result recorded in the memory. The result can be measured again in the same point and overwritten if the user doubts its reliability.

To see the results, switch to the CELL column. The ❄ character will be displayed on the screen (Figure 28).

Scrolling along the measurement results is performed successively by the cells of the groups according to the selected view direction. When the first/last cell in the group is reached, the program will switch to the next/previous group of the results correspondingly.

To correct a result, please perform the following:

- using the keys switch to the cell with the recorded result which will be corrected;
- while pressing and holding the  key, switch to the RESULT column, at that the ❄ sign will disappear.

Note: Actually, the result will remain in the memory up to the moment it will be recorded to the selected cell of new purpose. To return to the view mode not changing the result in the cell, press the  key.

- perform the measurement. If the measurement result is satisfactory, then press the "ENTER" button to record it into the selected cell. The instrument will automatically return to the view mode after doing it.

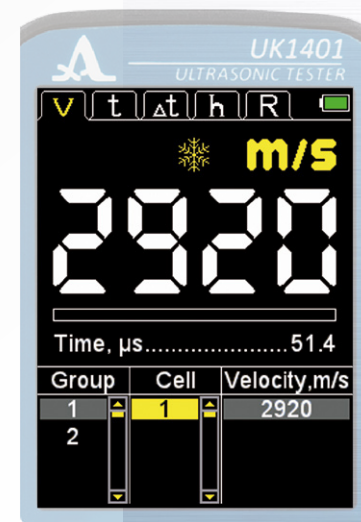
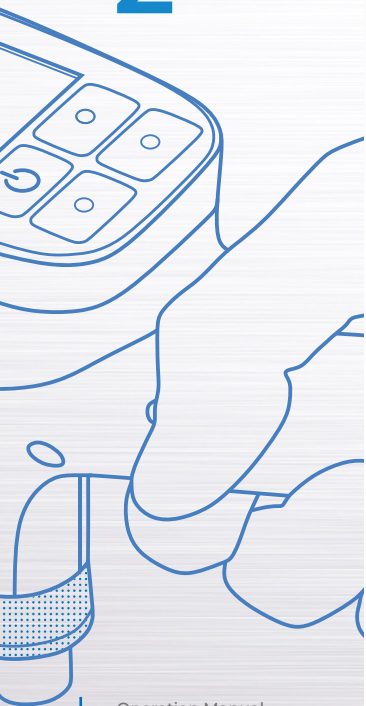

Figure 28

2



2.3.3 CRACK mode

The screen in the measurement mode of the crack depth is shown in the Figure 29.

In the lower part of the screen the intervals of the ultrasound propagation time are displayed if there is a crack crossing the propagation path of the signal between the ultrasonic transducers to the right, and to the left if there is no crack in the material.

The mode allows for the determination of the depth of the crack facing the surface. To do it, measure the ultrasound propagation time through the solid material near the crack, and then measure the signal propagation time through the crack. The instrument will calculate and display the value of the crack depth on the screen.

The instrument determines the DC crack depth (Figure 30) comparing the propagation time t_0 of the ultrasonic waves in the area without crack (path ADB) and t in the area with a crack (path ACB) using the formula:

$$DC = \frac{AB}{2} \cdot \sqrt{\frac{t^2}{t_0^2} - 1},$$

where: AB – distance (base of the instrument) between the transmitting transducer and the receiving transducer.



Figure 29

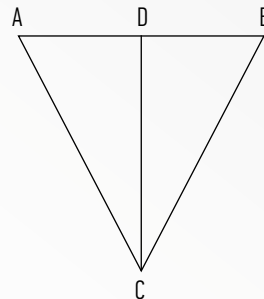
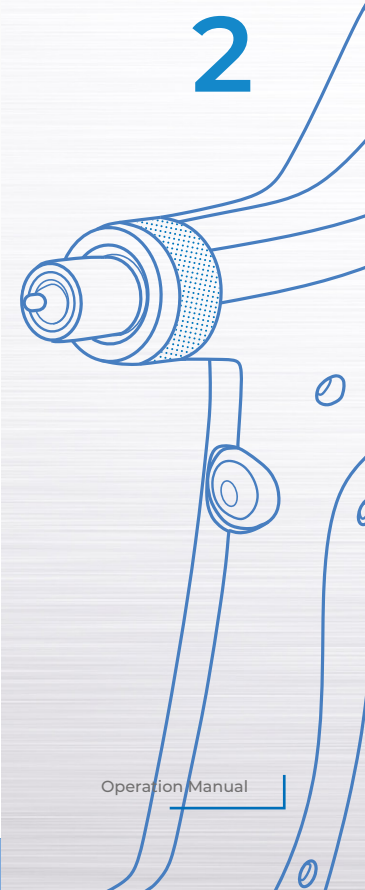

Figure 30

- To measure the crack depth, please perform the following:
- Press the instrument for 15 to 20 seconds onto the surface of the object being inspected parallel to the crack about 20 to 30 mm apart.
 - The instrument will measure the ultrasonic sound propagation time on the monolithic section of the inspected object "without crack".
 - Press the "ENTER" button to record it.
 - Place the transmitting and receiving transducers in such a manner that the crack is between them. To decrease an error, the crack must be possibly located at even distance to each transducer, and must be located perpendicular to lines of their placement.
 - The measured value of the crack depth will be displayed on the screen.
- If depth value of another crack shall be determined on the same object, then place the tester over another crack, etc.
- Note:** Do not press the "ENTER" button after the measurement of time over the crack, since in that case the instrument will take the measured time value as a basic one.

2



Operation Manual

2.3.4 FRONT mode

The mode allows for detection of front duration (time) of the first half wave (arrivals) of the ultrasonic signal from zero to the peak level; it allows for the quality evaluation of the concrete structure. In particular, the mode is used to monitor the supports of the railway contact network.

The screen in the measurement mode of the crack depth, within the set standard (green scale) and exceeding the set standard (red scale) is shown in the Figure 31.

Select an area without visible defects (cracks, grooves, air pockets, etc.) on the surface of the object to be inspected. The length of the area around the circle perimeter must be at least 180 mm, and height along the moving line must be at least 250 to 400 mm.

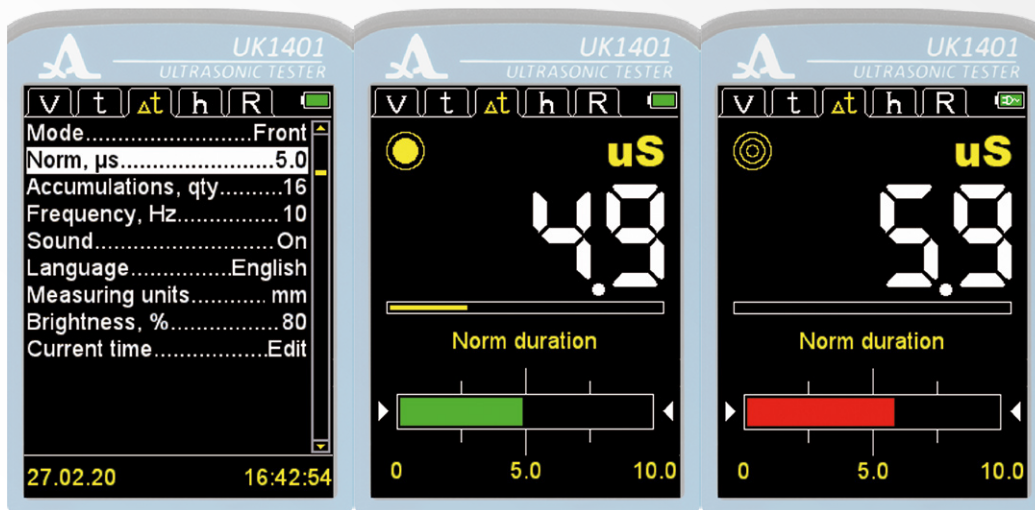

Figure 31

To measure the duration of the rising edge (front) of the signal, please perform the following:

- Press the instrument to the surface of the inspected object perpendicular to the main reinforcement and wait for 15-20 s.
- Remove the instrument from the inspected object. The measurement results will remain on the screen.
- Move the instrument in parallel up or down at a distance of 100-150 mm, and measure the second time.
- In the same manner, perform the third measurement, the duration of the third measurement shall be equal to the first wavefront.
- Determine the average value of three measurement results.
- Compare the received value to the rated value specified in the settings (for sound concrete with strength value specified by the project documentation, without significant structural damage).

If the received average measurement value of duration of the first front of the wave exceeds the above-named criterion value, then there is evidence of micro cracks presence and decreased concrete strength.





2.3.5 The STRENGTH mode

This mode is used to evaluate the concrete strength.

In the STRENGTH mode the display is divided into two parts: in the upper part the information on current measurement is indicated. In the lower part the information on the previously saved results in the STRENGTH mode is indicated (groups, groups of cells, measurement results) in MPa.

On the Figure 32 you see the display in the STRENGTH mode prior to save the results of the strength estimation.

The active buttons:

-   hold one of these buttons to move along the columns GROUP – CELL – OTHER, MPa in the appropriate direction;
-   press the button shortly to move along the lines of the active column in the appropriate direction.

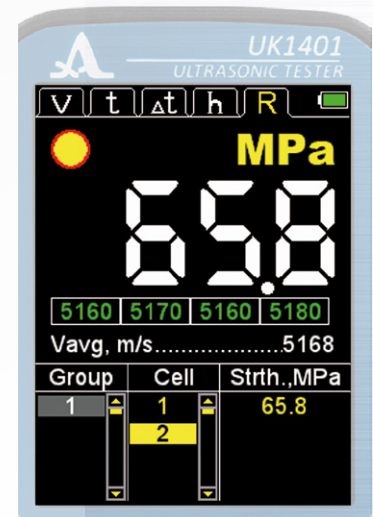

Figure 32

2.3.5.1 Process of measurement and result saving

Put the device on the tested object with both ultrasonic transducers and hold it so that the transducers are located at the right angles to the surface of the object. When the transducers touch the surface of the object the device directly switches to the stand-by mode and sends infrequent sounding pulses to the active state described by the frequent sound pulsing.

On the Figure 33 you see the display in the measurement mode.

When entering the measurement mode all progress bars are empty. The recommended position 1 for the device placement is shown.

To evaluate the strength four velocity measurements in the tested object are required. The device shall be positioned according to the recommendations on the screen.

Note – the velocity measured in each position is rounded to 10 m/s.

When the device is placed on the TO for the first time, the process of the velocity measurement V1 starts, the progress bar 1 is filled with yellow. After the velocity measurement process V1 is finished, the progress bar is completely filled with yellow and the measured value is shown in the line "Velocity". If you do not record the measured velocity value, the process of the velocity measurement V1 will be periodically repeated.

Note – if you take the device from the TO without recording the velocity, the velocity measurement results will be reset in 12 seconds.

You can record the velocity shown in the line „Velocity“ any time during the measurement process. To record it please press the button „ENTER“.

The recorded velocity will be shown in the field of the progress bar 1 in yellow and the process of the velocity measurement V2 will begin. The recommended position for the device installation will be shown on the screen.

The recording of the velocities V2, V3 and V4 is done similarly.

Note –to reset he recorded velocity values during the measurements press the key twice, i.e. enter the mode SET UP and exit it.

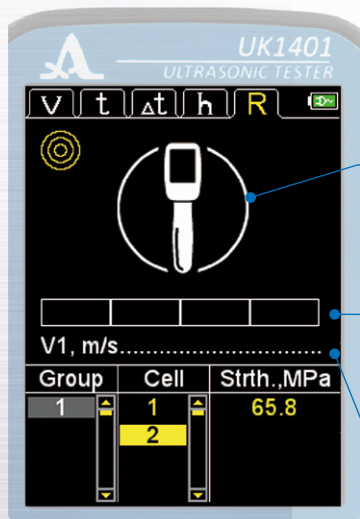

Recommended positioning of the instrument on inspection object

Progress-bar

Sound velocity value

Figure 33

If during the measurements you move to the viewing mode of the previously saved cell or start navigating through the groups, the recorded velocity values will be reset.

After recording the velocity V_4 the calculation of the mean velocity value V_m is performed. In the calculation of the mean value the results other than the arithmetical mean are involved differing from each other in 2% max. The values of the measured velocities involved in the calculation in the progress bar fields are highlighted green, the not-involved values are highlighted red.

The mean velocity value V_m is shown in the line "Velocity". On the screen you can see the corresponding calculated strength value.

To save the received strength value, please press the key "ENTER", to reset the received result and move to a new measurement cycle, please press any other key.

Note – the results is shown on the Figure for 12 seconds.

The display of the device during the measurement cycle is shown on the Figure 34.

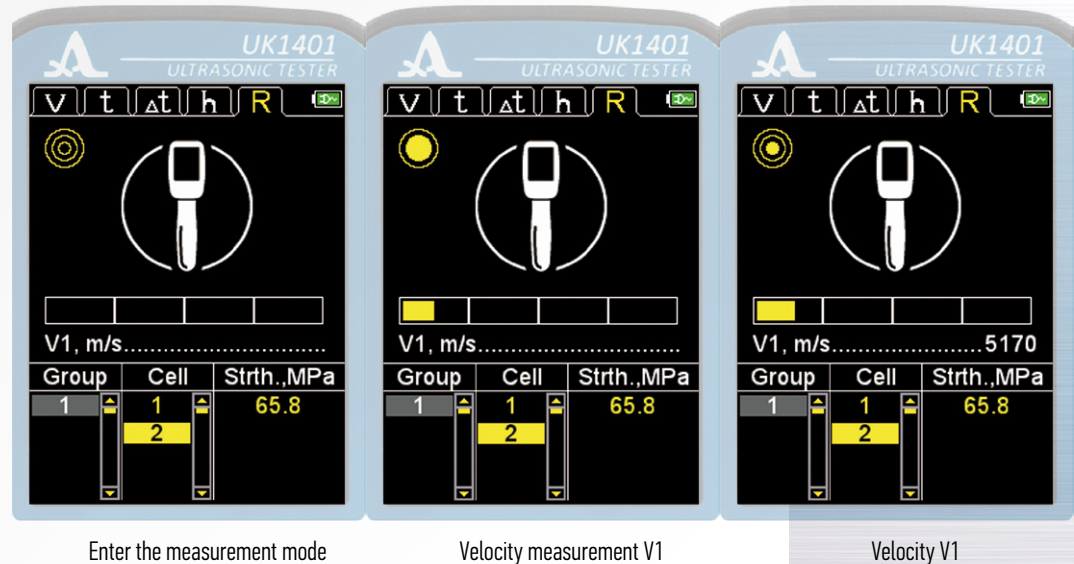
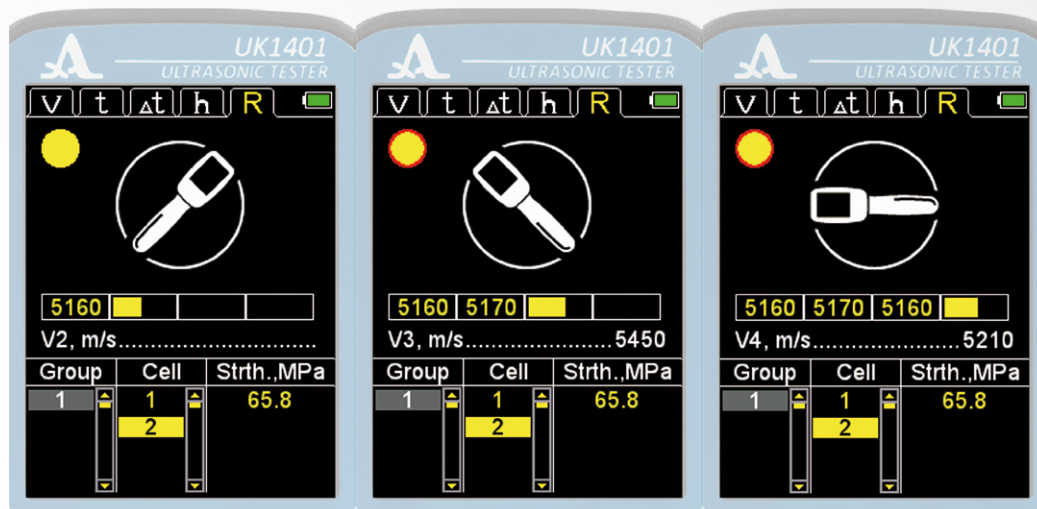

Figure 34

The results of the strength evaluation are saved on the device memory in the cells which form groups.
The work with cells and groups is similar to the modes VELOCITY, TIME and is described in the section n. 2.3.2.2. in detail.

Figure 34



Velocity measurement V2

Velocity measurement V3

Velocity measurement V4

Figure 34

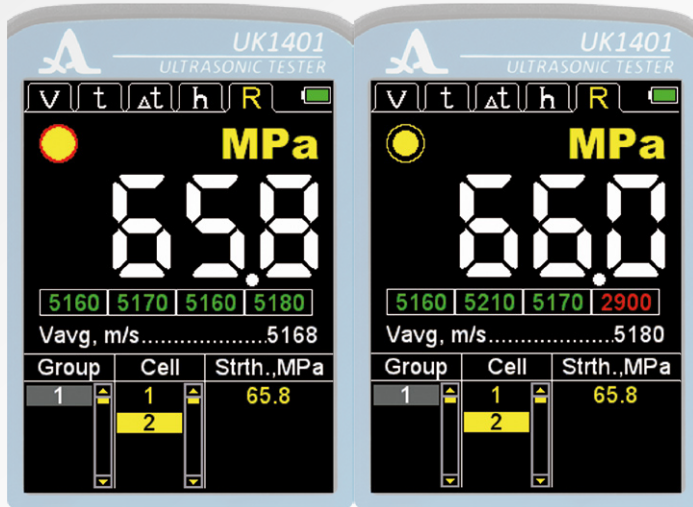

Calculation Vm based on 4 measurements (V1, V2, V3, V4 – green)

Calculation Vm based on 3 measurements (V1, V2, V3 – green, V4 – red)

In case the measurement results are beyond the range $V_m \pm 2\%$ the measurement is considered invalid (Figure 35).

In such a case:

- All results of the velocity measurement in the progress bars are highlighted red;
- The strength calculation is performed based on the results of all four recorded values of the measured velocity;
- The calculated strength value flashes and changes its color: red \leftrightarrow white;
- It is not possible to save the calculated strength value in the memory. When you try to save it, the following information appears "The results is not correct. Repeat the measurement";
- To return to the measurement mode, please press the key „ENTER“.

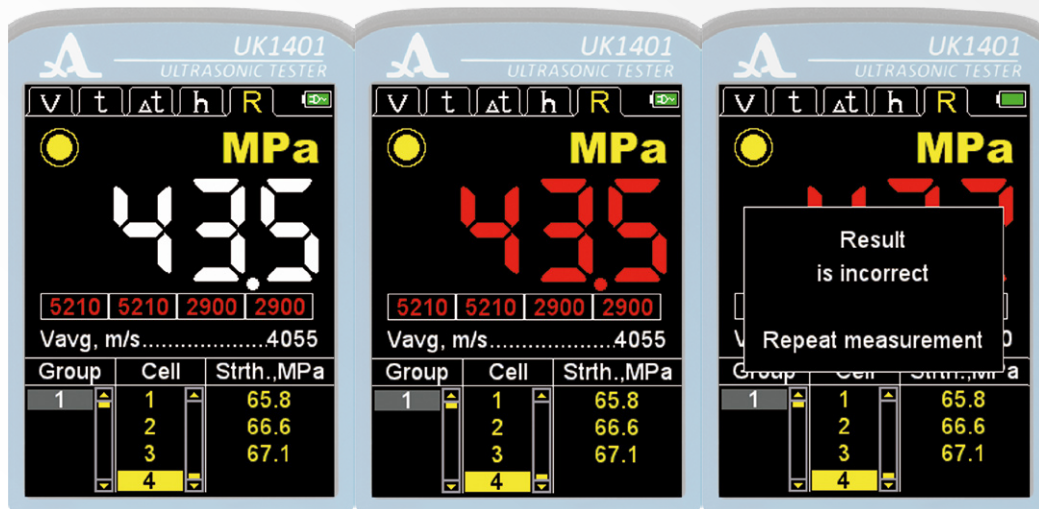

Figure 35

If the result of the strength evaluation is beyond the permissible range for the class of concrete selected in the **SET UP mode** (S. 2.3.1.2) the measurement is considered incorrect (e.g. when selecting in the settings of the **B35 – B60** class the permissible range is **45 – 75 MPa**, see the Figure 36. In such a case:

- All results of the velocity measurement in the progress bars are highlighted green;
- The strength calculation is performed based on the results of all four recorded values of the measured velocity;
- The calculated strength value flashes and changes its color: red ↔ white;
- It is not possible to save the calculated strength value in the memory. When you try to save it, the following information appears “The results is beyond the range boundaries 45...75 MPa”;
- To return to the measurement mode please press the key „ENTER”.

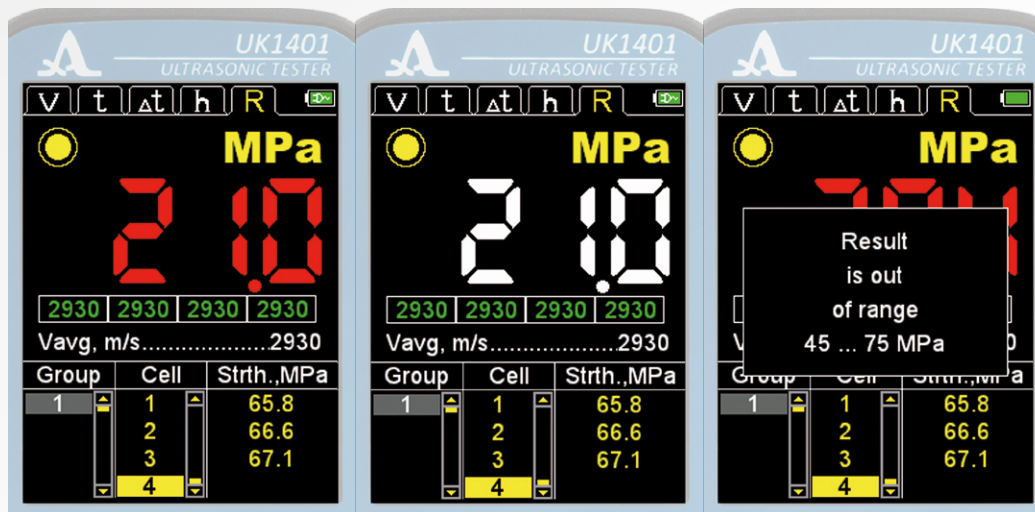

Figure 36





2.3.5.2 View and correct the measurement results

Any result recorded in the memory of the device can be viewed and in case of doubts that the result is reliable, it can be corrected by means of a repeated measurement and rewriting the uncertain value.

To view the results, go to the column CELL. The icon  appears on the screen (Figure 37).

To correct the result, please:

- Move to the cell, in which the result is written you wish to adjust;
- Hold the key  and move to the column with the result "OTHER, MPa", the icon  will disappear, the device will switch to the measurement mode.
- Perform the measurements;
- If you receive a satisfactory result within 12 seconds, press the key „ENTER“ to record the result in the selected cell you wish to adjust;
- The device returns to the result viewing mode.

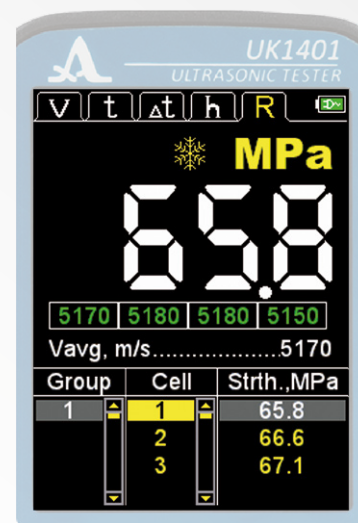

Figure 37

2.4 TRANSFER DATA TO PC

To transfer the data from the instrument to PC, please perform the following: connect the instrument to PC via the USB A – Micro B cable included in the delivery kit.

The OS will detect the instrument as an external removable disk named ACSYS DISC openable in the MS Windows “Explorer” or any File Explorer.

The data can be read directly from the instrument, as well as copied to PC.

You can name the data file as required for copying.

Numeric data are saved in the memory of the instrument in the CSV format (CommaSeparatedValues) convenient for export. Further, the measurement results can be analyzed and processed in the data sheet MS Excel (Figures 38 and 39). The data will be saved in a single file named RESULTS.CSV. The results will be arranged in the file according to the number of the group.

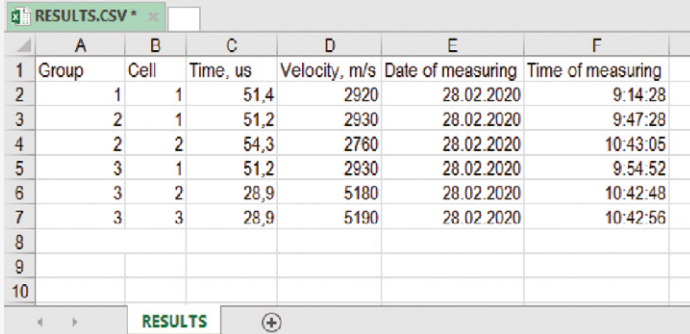

	A	B	C	D	E	F
1	Group	Cell	Time, us	Velocity, m/s	Date of measuring	Time of measuring
2		1	1	51,4	2920	28.02.2020 9:14:28
3		2	1	51,2	2930	28.02.2020 9:47:28
4		2	2	54,3	2760	28.02.2020 10:43:05
5		3	1	51,2	2930	28.02.2020 9:54:52
6		3	2	28,9	5180	28.02.2020 10:42:48
7		3	3	28,9	5190	28.02.2020 10:42:56
8						
9						
10						

Figure 38

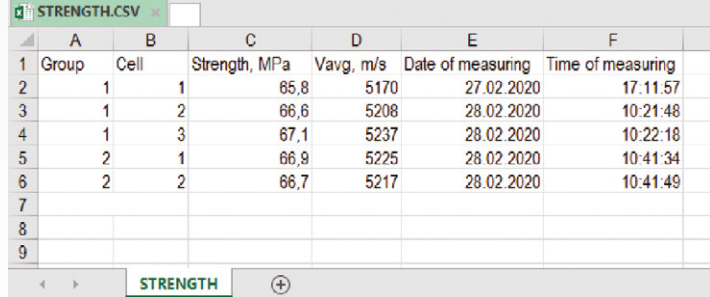

	A	B	C	D	E	F
1	Group	Cell	Strength, MPa	Vavg, m/s	Date of measuring	Time of measuring
2		1	1	65,8	5170	27.02.2020 17:11:57
3		1	2	66,6	5208	28.02.2020 10:21:48
4		1	3	67,1	5237	28.02.2020 10:22:18
5		2	1	66,9	5225	28.02.2020 10:41:34
6		2	2	66,7	5217	28.02.2020 10:41:49
7						
8						
9						

Figure 39



3

MAINTENANCE

The maintenance of the instrument includes cleaning the electronic unit from dirt and dust, and charging the battery.

3.1 ACCUMULATOR

The rechargeable battery is designed to be operated within a broad temperature range. At negative temperatures the battery capacity is reduced. At low temperatures the capacity is 15% below the capacity at normal temperatures.

The instrument will automatically switch off when the battery is completely discharged.

The accumulator is equipped with built-in battery overcharge protection, over discharge, over current and over temperature.

The battery service life is designed for the guaranteed service life of the instrument.

The battery shall be replaced by service centers only.

ATTENTION: THE INSTRUMENT WARRANTY WILL BE VOIDED, IF THE USER REPLACES THE BATTERY INDEPENDENTLY!

3.2 CHARGING THE ACCUMULATOR

The battery shall be charged via the external charger or PC.

The charging time depends on the depletion of the accumulator. The total charge time is 4 to 5 hours. Multi-recharging is allowed.

The instrument can be operated during battery charging, though the charging time will increase to 2 to 3 times.

ATTENTION: NEVER STORE THE INSTRUMENT WITH THE DISCHARGED BATTERY TO PREVENT ITS FAILURE!

3.3 TROUBLESHOOTING

Contact the representatives of the manufacturer if you have questions about operation of the instrument to get assistance and consult the experts.

4

STORAGE

The instrument should be shelf stored in the hard case included in the delivery kit. The storage conditions shall correspond to GOST 15150-69 (placement category 1).

The arrangement of the instruments in warehouses shall enable their free movement by the personnel and unrestricted access to them.

The distance between the instruments and the walls, floor of the warehouse and other instruments in the warehouse shall be at least 100 mm.

The distance between the heating units in the warehouse and the instruments shall be at least 0.5 m.

The storage room shall be free from the current-conducting dust, admixtures of aggressive gases and corrosive vapors able to attack the instruments.



5

TRANSPOR- TATION

The instrument shall be transported in the hard case included in the delivery kit.
The transportation conditions with regard to the impact of the external environmental factors should correspond to the storage conditions (placement category 5) according to GOST 15150-69.

The packaged instruments can be transported in any vehicles to any distances without speed limits.

The packaged instruments should be properly and steadily fixed to prevent shocks of devices against each and against vehicle walls during the transportation. When transported in open vehicles the instruments shall be protected against rain and water splashes.

The terms and conditions of transportation must comply with requirements of technical standards and code of practice applicable for a given means of transport individually.

If shipped by air, properly packed instruments should be placed in hermetically sealed and heated compartments.

In case the transportation conditions differ from the operation conditions, the instruments shall be kept under normal environmental conditions for at least 2 hours prior to operation.

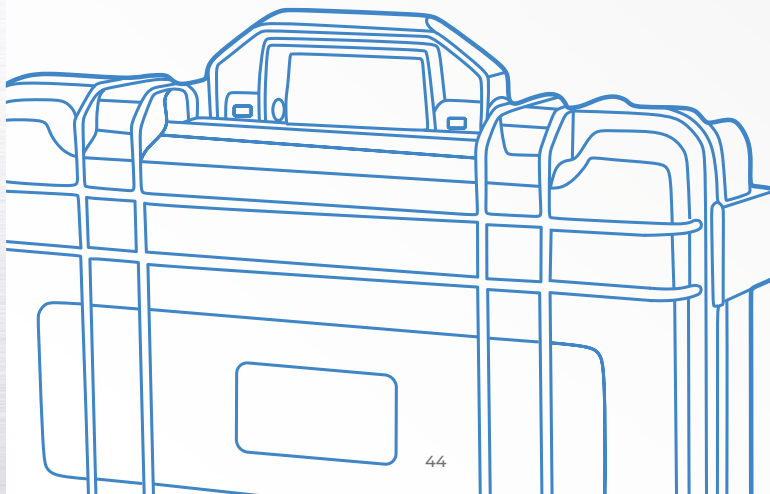



NOTES



ULTRASONIC TESTER

UK1401 SURFER



OPERATION MANUAL

Revision: March 2020